

Measuring transducers (True RMS)

I 420 transducers for AC current

U 420 transducers for AC voltage

I 420 and U 420 are transducers for measuring not sinusoidal AC current/voltage, either directly or via a transformer.

The output gives a load independent DC signal that can be connected to one or several receiving instruments such as panel indicators, recorders, regulators or distant controllers. The transducers work with power supply and have galvanic separation between input, output and power supply.

Transducers in plastic case are mounted directly on profiled bars TS35. Connection to selfopening clamps for max 6 mm² wires. Transducers for mounting in 19" racks have width 8 TE, which gives place for 10 modules in a rack.

The transducers are manufactured according to IEC 688.

Order facts:

Enclosed for mounting on profiled bar 35 EN 50022	19" rack modul (wide 8 TE)	
Type	Type	
I 420L-15x	I 420R-15x	
U 420L-15x	U 420R-15x	
Replace x with last digit for output according to table below		
Output	External resistans load	Last digit x
0 - 5 mA	0-5000 Ω	1
0 -10 mA	0-1500 Ω	2
0 -20 mA	0- 750 Ω	3
4 -20 mA	0- 750 Ω	4
0 -10 V	> 700 Ω	5

Order form:

Current transducer **I 420L-154**
 Input 0 - 5 A, 50 Hz
 Output 4 - 20 mA
 Power supply 230 V, 50 Hz
 Enclosed for mounting on profiled bar 35 EN 50022

IU420-FA



IU420-FB

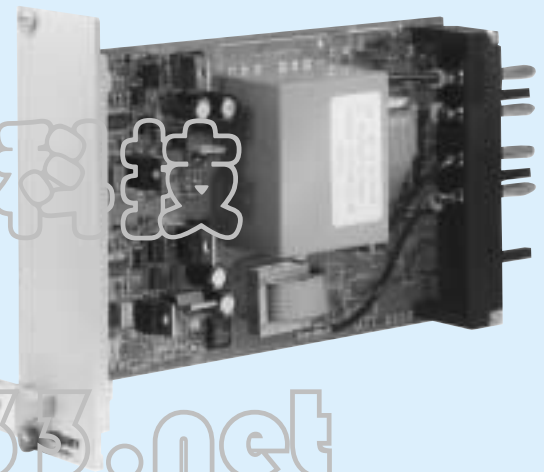

Technical data

Input I 420

Measuring range Any value between 300 mA and 10 A
 Frequency 15...40-70...1000 Hz
 Consumption (burden) < 0,05 VA
 Overload 2 × I_{in} continuously
 10 × I_{in} during 15 s
 40 × I_{in} during 0,5 s

Input U 420

Measuring range Any value between 10 and 500 V
 (Rack version max 300 V)
 Frequency 15...40-70...1000 Hz
 Consumption (burden) < U_{in} × 1 mA, VA
 Overload 1,5 × U_{in} continuously
 2 × U_{in} during 10 s

Output

Current output signal: min 0-1 mA
 max 0-20 mA
 Standard ranges 0...5/10/20 mA, 4-20 mA
 Load max 15 V
 Current limitation < 30 mA
 Voltage: 0-10 V
 Burden >700 Ω
 Ripple < 1% p.p.

General data

Accuracy class 0,5 according to IEC 688
 0,2 on request
 Linearity error < 0,1%
 Response time 0-90% < 250 ms
 Temperature influence < 0,1% / 10°C
 Temperature range -25...+60°C operation
 -40...+70°C storage
 Test voltage 5,6 kV, 50 Hz, 1 min
 (Rack version 3,7 kV)
 Power supply 24, 110, 230 VAC ±15%, 47-70 Hz, ca 2 VA
 24-130 VDC ±20%, ca 2,5 W
 Weight 0,5 kg

Options on request

Standards

General standards for measuring transducers EN 60688, IEC 688
 EMC emission EN 50081-2
 immunity EN 50082-2*)
 Safety EN 61010-1, IEC 1010-1
 Inputs overvoltage cat. III
 Outputs overvoltage cat. II
 Pollution degree 2

*) At certain frequencies can minor deviations from the class accuracy occur during the disturbance

Design

The transducer consists of an input transformer that transforms the input signal to a proper level and at the same time gives galvanic separation between in- and output.

In the next stage squaring and dividing is made after which the signal is fed to the output amplifier. Here the signal is transformed to a proportional load independent DC signal.

In case of DC power supply a switched unit is used which gives galvanic separation and covers the whole span 24-130 VDC.

In case of AC the power supply is taken from a transformer which gives galvanic separation. Parts that need separate power are fed via a rectifier stage.

IU420DCE

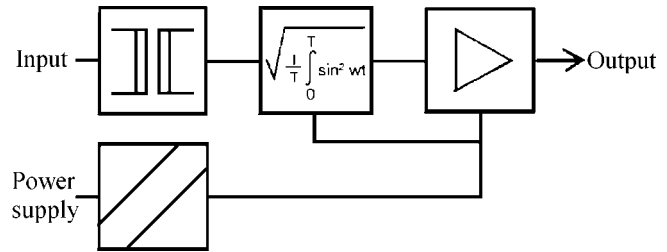

Connection diagrams

I/U 420 L

IU400LE

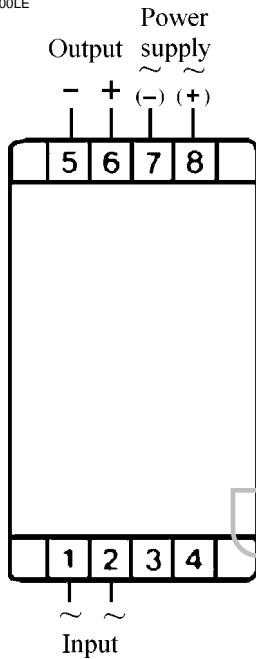

I 420R

I420RE

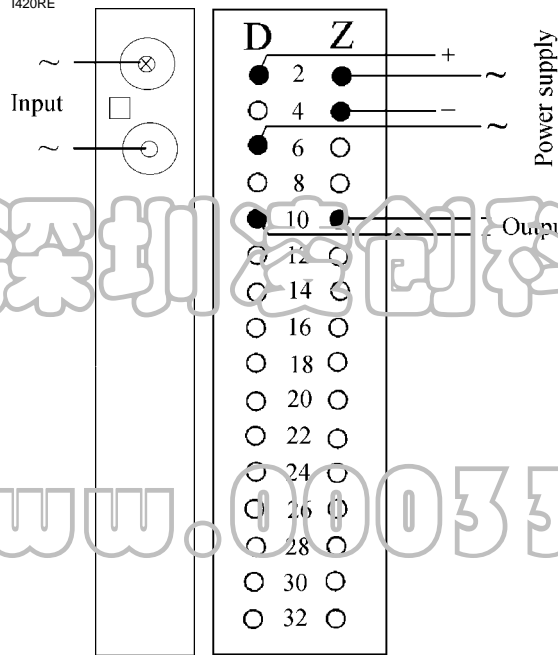

U 420R

U420RE

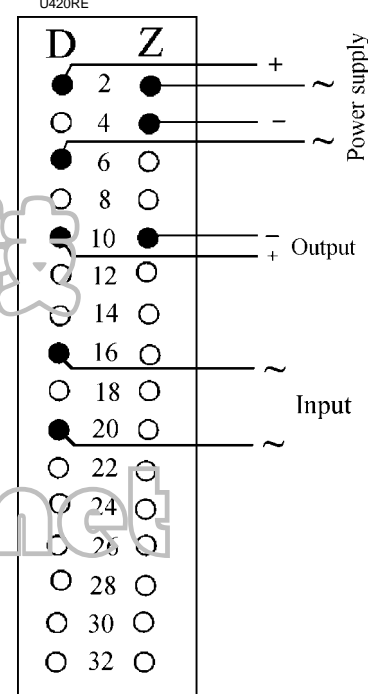

Dimensions, mm

I/U 420L

MATOMVME

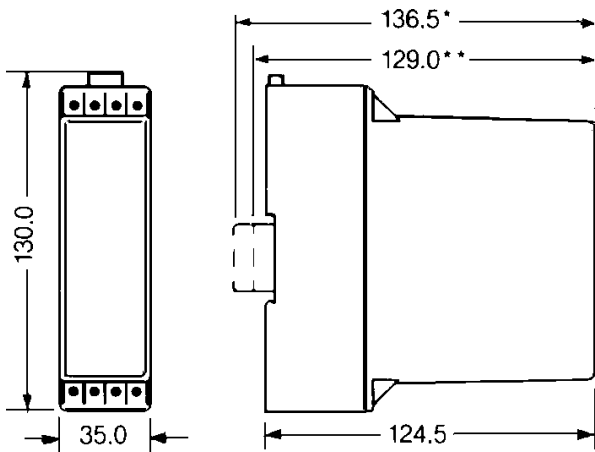

I/U 420R

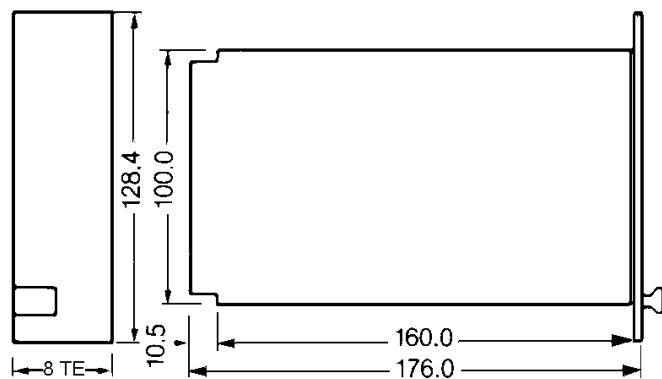

*) Profile bar 35 EN 50022, height 15 mm

**) Profile bar 35 EN 50022, height 7,5 mm